

## Features

- Auto-sense
- Non-Isolated
- Synchronous rectification design
- Adjustable Output voltage
- 2, 3, 4 & 5AMP Adjustable Positive Step Down Integrated Switching Regulator
- Over load protection (125% full load typical)
- Remote ON/OFF Control(Ground Off)
- Wide Input Range
- UL94V-0 Package Material
- Continuous short circuit protection (Short Circuit Input Current,  $I_{in\ sc} < 50mA$ )
- Input voltage range 4.5V~18V
- Efficiency to 96%

Rev.1

## Description

The R-5XXX series is a high performance 1.2V to 5.0V , 2Amp to 5Amp, 12-Pin SIP (single in-line package) integrated switching regulator (ISR). Synchronous - rectified design yields excellent efficiencies up to 96%. Short circuit protection with crowbar function to reduce the short circuit input current to under 50mA. Autosense function compensates for any losses in long circuit loops.

## Selection Guide

Part Number SIP12	Input Range (V)	Nominal Output Voltage (V)	Vout Adjust Range (V)	Output Current (A)	Efficiency		
					min.Vin (%)	12V (%)	max.Vin (%)
R-521.2xA	4.5 – 18	1.2	1.0 – 3.0	2	83	79	75
R-521.8xA	4.5 – 18	1.8	1.1 – 4.5	2	88	85	82
R-522.5xA	4.5 – 18	2.5	1.6 – 5.5	2	91	88	86
R-523.3xA	4.5 – 18	3.3	1.6 – 5.5	2	92	90	89
R-525.0xA	6.5 – 18	5.0	3.0 – 5.5	2	95	93	92
R-531.2xA	4.5 – 18	1.2	1.0 – 3.0	3	85	84	82
R-531.8xA	4.5 – 18	1.8	1.1 – 4.5	3	89	88	86
R-532.5xA	4.5 – 18	2.5	1.6 – 5.5	3	92	91	89
R-533.3xA	4.5 – 18	3.3	1.6 – 5.5	3	94	93	92
R-535.0xA	6.5 – 18	5.0	3.0 – 5.5	3	96	95	94
R-541.2xA	4.5 – 18	1.2	1.0 – 3.0	4	82	81	79
R-541.8xA	4.5 – 18	1.8	1.1 – 4.5	4	87	86	85
R-542.5xA	4.5 – 18	2.5	1.6 – 5.5	4	91	89	88
R-543.3xA	4.5 – 18	3.3	1.6 – 5.5	4	93	92	91
R-545.0xA	6.5 – 18	5.0	3.0 – 5.5	4	95	94	93
R-551.2xA	4.5 – 18	1.2	1.0 – 3.0	5	81	80	78
R-551.8xA	4.5 – 18	1.8	1.1 – 4.5	5	86	85	84
R-552.5xA	4.5 – 18	2.5	1.6 – 5.5	5	90	89	88
R-553.3xA	4.5 – 18	3.3	1.6 – 5.5	5	92	91	90
R-555.0xA	7.0 – 18	5.0	3.0 – 5.5	5	94	93	92

Note:  $V_{in} - V_{out} \geq 1.5V$  if adjust function is used!

Suffix x: (see mechanical drawing for details)

x = P pins vertical through hole

x = D pins bent for horizontal through hole mounting

**INNOLINE**  
DC/DC-Converter

**R-5xxxPA**  
**\_DA Series**

**2, 3, 4, 5 AMP**  
**SIP12**

**Vertical &**  
**Horizontal**



**RECOM**

**Specifications (refer to the standard application circuit, Ta: 25°C)**

Characteristics	Conditions	Min.	Typ.	Max.
Output Voltage Range	All Series	0.8		6.0V
Output Current	R-52xxPA/DA R-53xxPA/DA R-54xxPA/DA R-55xxPA/DA	0.2 0.3 0.4 0.5		2.0A 3.0A 4.0A 5.0A
Output Current Limit	R-52xxPA/DA R-53xxPA/DA R-54xxPA/DA R-55xxPA/DA		2.5 3.75 5.0 6.0	3.0A 4.25A 5.5A 6.5A
Short Circuit Input Current	All Series			50mA
Short Circuit Protection			Continuous, automatic recovery	
Output Voltage Accuracy	At 100% Load All Series		±1%	±2%
Line Voltage Regulation (Vin = min. to max. at full load)	R-52xxPA/DA R-53xxPA/DA & R-54xxPA/DA & R-55xxPA/DA		0.25 0.5	0.5% 1.0%
Load Regulation (10 to 100% full load)	R-52xxPA/DA R-53xxPA/DA & R-54xxPA/DA & R-55xxPA/DA		0.5 1.0	1.0% 2.0%
Ripple & Noise	R-52xxPA/DA R-53xxPA/DA & R-54xxPA/DA & R-55xxPA/DA		40mVp-p 80mVp-p	70mVp-p 120mVp-p
Transient Response (see note 1)	50% Load Change Vout Over / Undershoot		100µs	200µs 100mV
Remote ON / OFF (see note 2) (positive logic)	Open or High (Power ON) Low (Power OFF)	4.5		18V 0.8V
Remote Off Input Current	Remote ON/OFF low level			100µA
Switching Frequency		270	300	330kHz
Quiescent Current	Vin = min. to max. at 0% load			20mA
Operating Temperature Range		-40°C		+85°C
Storage Temperature Range		-40°C		+125°C
Internal Power Dissipation	Io x Vo x (1-Efficiency)			1.4W
Package Weight				9g
MTBF (Nominal Vout, 100% load)	Tamb. = +25°C Tamb. = +85°C			749 x 10 <sup>3</sup> hours 150 x 10 <sup>3</sup> hours

**Notes:**

- Requires an electrolytic or tantalum output capacitor for proper operation in all applications (the capacitor to be placed as close as possible to the output pins)  
100µF for R-52xxPA/DA, R-53xxPA/DA and R-54xxPA/DA or 220µF for R-55xxPA/DA.
- ON / OFF pin driven by TTL (logic gate), open-collector bipolar transistor or open-drain MOSFET.
- Output Current vs. Input Voltage (see graph below).

**Output Current vs Input Voltage**

**How to calculate the max output current**

The internal power dissipation(P<sub>D</sub>)follows the equation:

$$P_D = I_o \times V_o \times (1-\eta)$$

$$I_o = P_D / V_o \times (1-\eta)$$

Where P<sub>D</sub> = Internal power dissipation

I<sub>o</sub> = Output current

V<sub>o</sub> = Output voltage

η = Efficiency

Example: R-545.0P, at Vin = 18Vdc, Vo = 5Vdc, η=93% (see "Selection Guide" table)

(a) When Ta = 60°C, P<sub>D</sub> = 1.4 Watt (see adjacent diagram)

$$I_o = 1.4(W) / 5(V) \times (1-0.93) = 4(A)$$

(b) When Ta = 85°C, P<sub>D</sub> = 1 Watt (see adjacent diagram)

$$I_o = 1(W) / 5(V) \times (1-0.93) = 2.857(A)$$

(c) At Vin = 12Vdc efficiency = 94% (see "Selection Guide" table)

When Ta = 85°C, P<sub>D</sub> = 1 Watt (see adjacent diagram)

$$I_o = 1(W) / 5(V) \times (1-0.94) = 3.33(A)$$

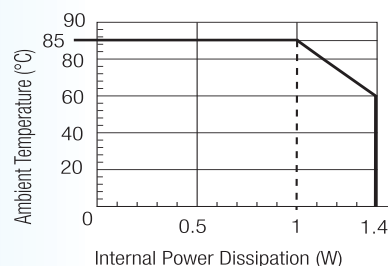

## Standard Application Circuit

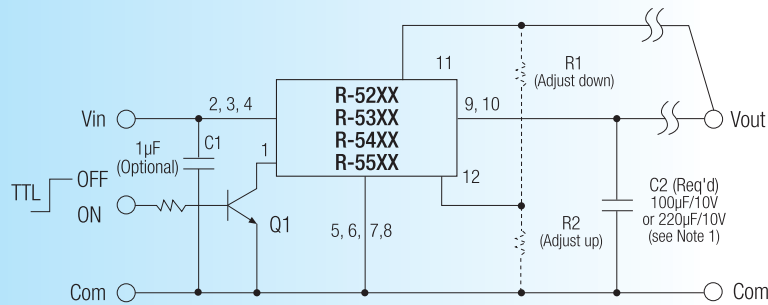

Add a blocking diode to Vout if current can flow backwards into the output, as this can damage the converter..

## Parallel Application Circuit

The R-52xx, R-53xx, R-54xx series can be used in parallel to upgrade the output current capacity for the same output voltage.

For example, the R-543.3PA can parallel up with another R-554.3PA to give up to 8 amps or with the R-533.3PA or R-523.3PA types to give output currents of up to 7 Amps or 6 Amps.

The R-55xx series cannot be paralleled.

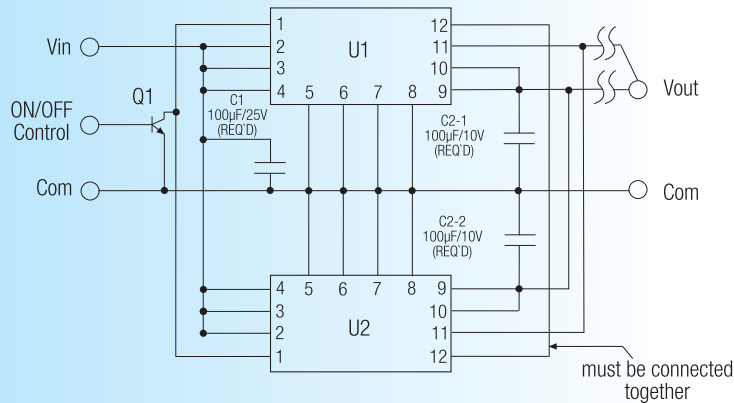

## Component side

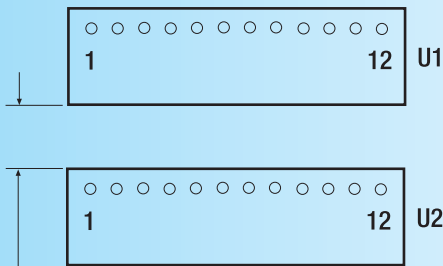

Keep 2mm to 5mm distance between both converters

## Solder side

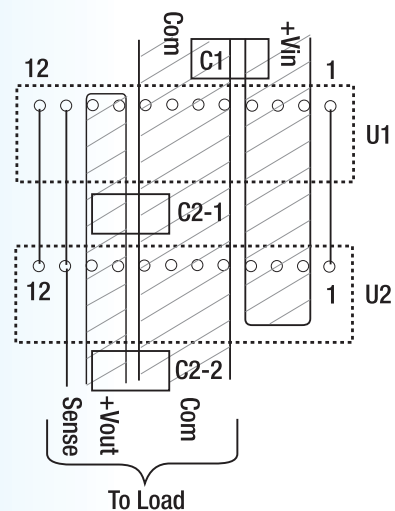

**Characteristics**

**R-53xx / R-54xx**  
Output Voltage Line Regulation VS Vout

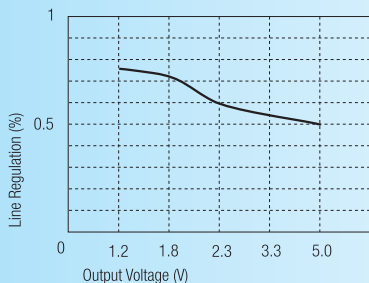

**R-52xx / R-55xx**  
Output Voltage Line Regulation VS Vout

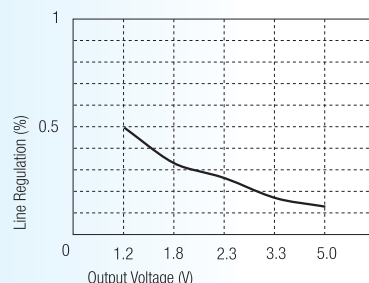

**R-53xx / R-54xx**  
Input Voltage Load Regulation VS Vin

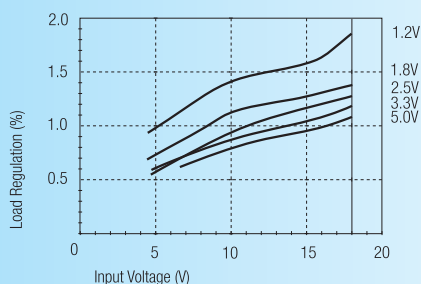

**R-52xx / R-55xx**  
Input Voltage Load Regulation VS Vin

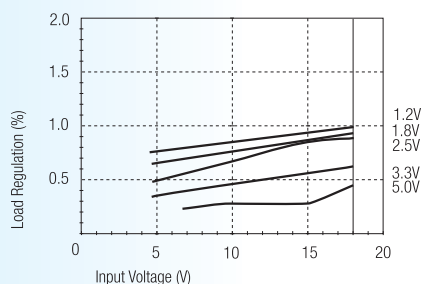

**R-53xx / R-54xx / R-55xx**  
Output Current Efficiency vs I<sub>out</sub> (Vin = Min)

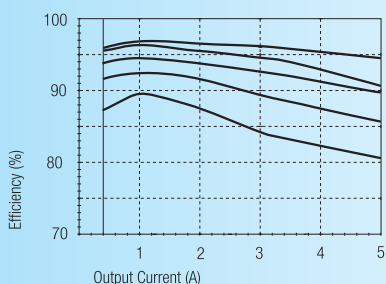

**R-52xx**  
Output Current Efficiency vs I<sub>out</sub> (Vin = Min)

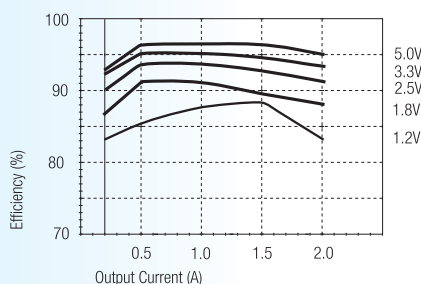

**R-53xx / R-54xx / R-55xx**  
Output Current Efficiency vs I<sub>out</sub> (Vin = 18V)

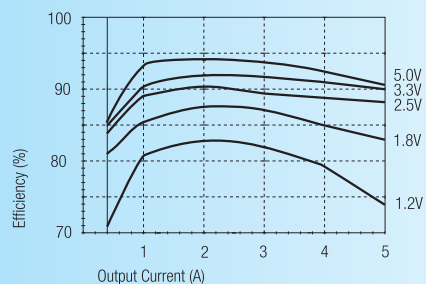

**R-52xx**  
Output Current Efficiency VS I<sub>out</sub> (Vin = 18V)

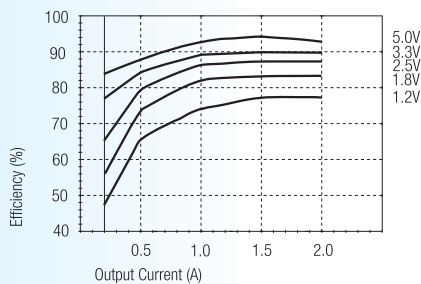

**Table 1: Adjustment Resistor Values**

2A <sub>dc</sub>	R-521.2PA/DA		R-521.8PA/DA		R-522.5PA/DA		R-523.3PA/DA		R-525.0PA/DA	
3A <sub>dc</sub>	R-531.2PA/DA		R-531.8PA/DA		R-532.5PA/DA		R-533.3PA/DA		R-535.0PA/DA	
4A <sub>dc</sub>	R-541.2PA/DA		R-541.8PA/DA		R-542.5PA/DA		R-543.3PA/DA		R-545.0PA/DA	
5A <sub>dc</sub>	R-551.2PA/DA		R-551.8PA/DA		R-552.5PA/DA		R-553.3PA/DA		R-555.0PA/DA	
V <sub>out</sub> (nominal)	1.2V <sub>dc</sub>		1.8V <sub>dc</sub>		2.5V <sub>dc</sub>		3.3V <sub>dc</sub>		5.0V <sub>dc</sub>	
V <sub>out</sub> (adj)	R1	R2	R1	R2	R1	R2	R1	R2	R1	R2
0.8 (V)										
0.9 (V)	740Ω									
1.0 (V)	3.9KΩ									
1.1 (V)	13KΩ		1.05KΩ							
1.2 (V)			2.1KΩ		270Ω					
1.3 (V)		37KΩ	3.7KΩ		750Ω					
1.5 (V)		11.5KΩ	10KΩ		2.1KΩ		390Ω			
1.6 (V)		8.2KΩ	18KΩ		3.0KΩ		750Ω			
1.7 (V)		6.5KΩ	41KΩ		4.1KΩ		1.2KΩ			
1.8 (V)		5.2KΩ			5.6KΩ		1.7KΩ			
1.9 (V)		4.3KΩ		36KΩ	7.5KΩ		2.2KΩ			
2.0 (V)		3.6KΩ		1.8KΩ	10.5KΩ		2.8KΩ			
2.4 (V)		2.1KΩ		5.2KΩ	82KΩ		6.8KΩ			
2.5 (V)		1.8KΩ		4.3KΩ			8.5KΩ			
2.6 (V)		1.65KΩ		3.6KΩ		33KΩ	10.5KΩ			
3.0 (V)		1.05KΩ		2.1KΩ		6.2KΩ	33KΩ		470Ω	
3.2 (V)				1.65KΩ		4.1KΩ	110KΩ		1.6KΩ	
3.3 (V)				1.5KΩ		3.4KΩ			2.2KΩ	
3.4 (V)				1.35KΩ		2.9KΩ		36KΩ	3.0KΩ	
3.6 (V)				1.07KΩ		2.2KΩ		11KΩ	4.7KΩ	
3.9 (V)				780Ω		1.4KΩ		4.7KΩ	8.5KΩ	
4.5 (V)				390Ω		650Ω		1.6KΩ	30KΩ	
4.9 (V)						350Ω		820Ω	220KΩ	
5.0 (V)						290Ω		680Ω		
5.1 (V)						220Ω		560Ω		28KΩ
5.5 (V)						39Ω		190Ω		2.6KΩ