

## Features

- Efficiency up to 96%, Non isolated, no need for heatsinks
- Pin-out compatible with LM78XX Linear
- Low profile( L\*W\*H=11.5\*8.5\*17.5mm)
- High voltage input range, up to 72V
- Short circuit protection, Thermal shutdown
- Non standard outputs available as specials between 3.3V~24V
- Low ripple and noise
- "L" version with 90° pins
- See Positive to Negative Converter Application Note for use as a voltage inverter (alternative to LM79xx Linear)

Rev.0

## Description

The R-78HBxx-Series high efficiency, high input voltage switching regulators are ideally suited to replace 78xx linear regulators and are pin compatible. The efficiency of up to 96% means that very little energy is wasted as heat so there is no need for any heat sinks with their additional space and mounting costs.

An input voltage range of up to 8:1 is unsurpassed by any other converter and allows the full stored energy utilisation of standard and high voltage batteries. The fully protected output is ideal for industrial applications (especially for industry standard 24VDC bus supplies) and the L-Version with 90° pins allows direct replacement for laid-flat regulators where component height is at a premium. Low ripple and noise figures and a short circuit input current of typically only 15mA round off the specifications of this versatile converter series.

Typical applications include telecommunication, automotive, industrial, aerospace and battery powered applications.

## Selection Guide

Part Number SIP3	Input Range (V)	Output Voltage (V)	Output Current (A)	Efficiency		
				Vmin. (%)	30V (%)	72V (%)
R-78HB3.3-0.5	9 - 72	3.3	0.5	82	80	76
R-78HB5.0-0.5	9 - 72	5.0	0.5	87	85	81
R-78HB6.5-0.5	9 - 72	6.5	0.5	91	87	84
R-78HB9.0-0.5	14 - 72	9.0	0.5	92	90	86
R-78HB12-0.5	17 - 72	12	0.5	94	93	89
R-78HB15-0.5	20 - 72	15	0.5	95	94	91
R-78HB24-0.3	36 - 72	24	0.3	96		92

\* add Suffix "L" for 90° bent pins, e.g. R-78HB5.0-0.5L

## Typical Application Circuit

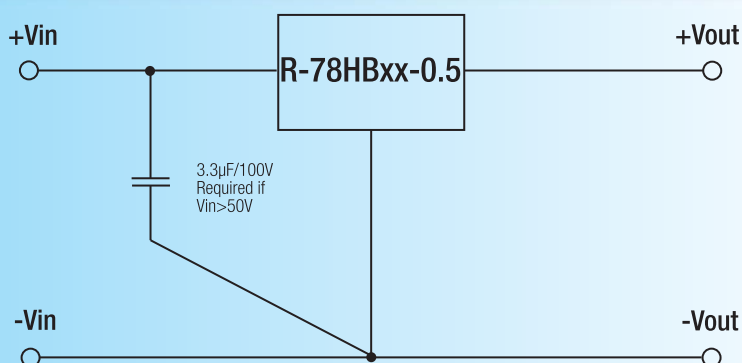

The converter has a built in soft start circuit. Rapidly changing the input voltage from Vin(min) ↔ Vin(max) can bypass this circuit and damage the converter.

**INNOLINE**  
DC/DC-Converter

# R-78HBxx- 0.5(L) Series 0.5 AMP SIP3 Single Output

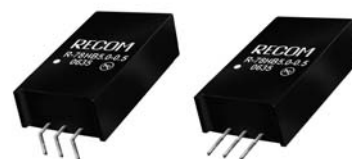

**EN-55022 Certified**  
**EN-55024 Certified**  
**EN-60601-1-2 Certified**  
**EN-60950-1 Certified**

**RECOM**

## Derating-Graph (Ambient Temperature)

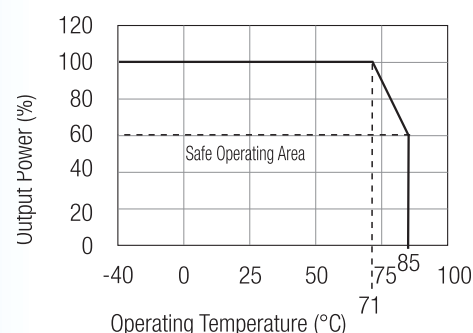

# R-78HBxx-0.5 (L) Series

Specifications (refer to the standard application circuit, Ta: 25°C, minimum load = 10%)

Characteristics	Conditions	Min.	Typ.	Max.
Input Voltage Range	See table	9	48	72V
Output Voltage Range (for customized parts)	All Series	3.3		24V
Output Current (see Note 1)	3.3V, 5V, 6.5V, 9V, 12V, 15V	10		500mA
	24V	6		300mA
Output Current Limit (Vin = 48VDC)	All Series		700	1200mA
Short Circuit Input Current	All Series		15	25mA
Internal Input Filter				1µF Capacitor
Internal Power Dissipation				0.65W
Short Circuit Protection			Continuous, automatic recovery	
Output Voltage Accuracy	At 100% Load		±2	±3%
Line Voltage Regulation	Vin = min. to max. at full load		0.4	1%
Load Regulation	10% to 100% full load		0.3	0.6%
Dynamic Load Stability (with Output Capacitor=100µF)	100% <-> 50% load		±75mV	±100mV
Ripple & Noise (without Output Capacitor)	10% to 100% full load		20mVp-p	60mVp-p
Temperature Coefficient	-40°C ~ +85°C ambient			0.015%/°C
Max capacitance Load				100µF
Switching Frequency (See Graph)	Full Load	120		800kHz
Quiescent Current	Vin = 48VDC. at minimum load	1		5mA
Operating Temperature Range		-40°C		+85°C
Operating Case Temperature				+100°C
Storage Temperature Range		-55°C		+125°C
Case Thermal Impedance				60°C / W
Thermal Shutdown	Internal IC junction			+160°C
Relative Humidity				95% RH
Package Weight				4g
Case Material				Non-Conductive Black Plastic
Potting Material				Epoxy (UL94V-0)
Soldering Temperature				265°C max./10 sec.
Conducted Emissions	EN55022	Class B		
Radiated Emissions	EN55022	Class B		
ESD	EN61000-4-2	Class A		
CE Certified				EN-60950-1
MTBF (+25°C)	} Detailed Information see Application Notes chapter "MTBF"	using MIL-HDBK 217F		7395 x 10 <sup>3</sup> hours
(+71°C)		using MIL-HDBK 217F		1242 x 10 <sup>3</sup> hours

\*Note: Operation under no load will not damage these devices, however they may not meet all specifications. A minimum load of 10mA is recommended

Typical Characteristics

## Efficiency

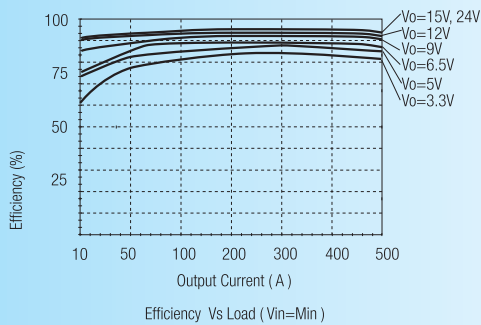
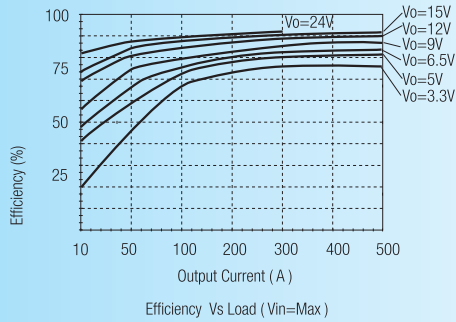
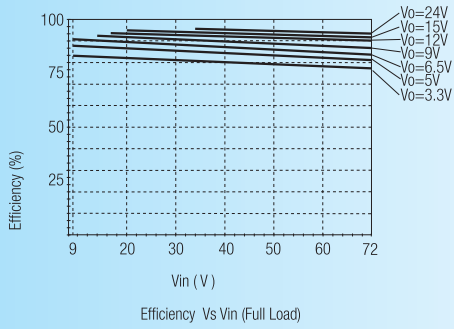

## Ripple

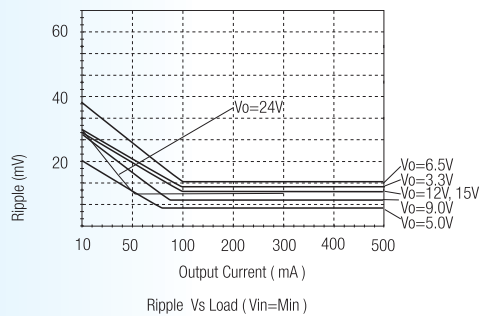
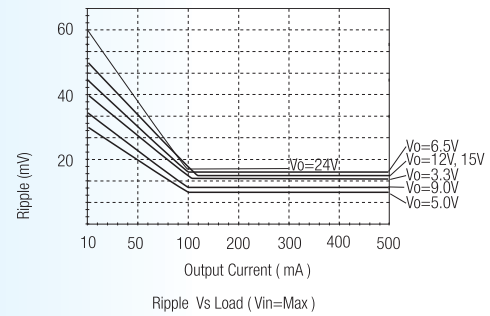
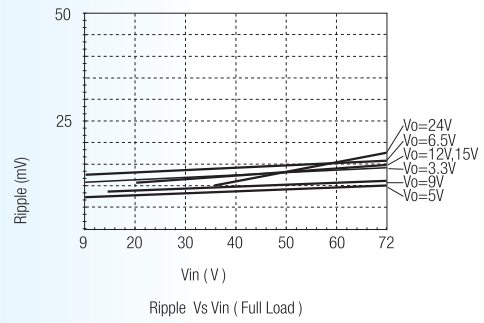

## Switching Frequency

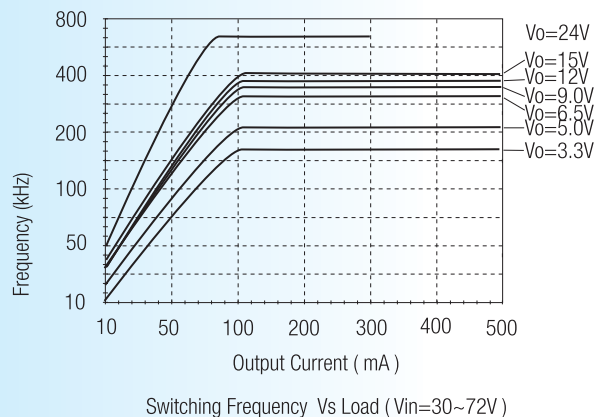

# R-78HBxx-0.5 (L) Series

## Typical Application Circuit

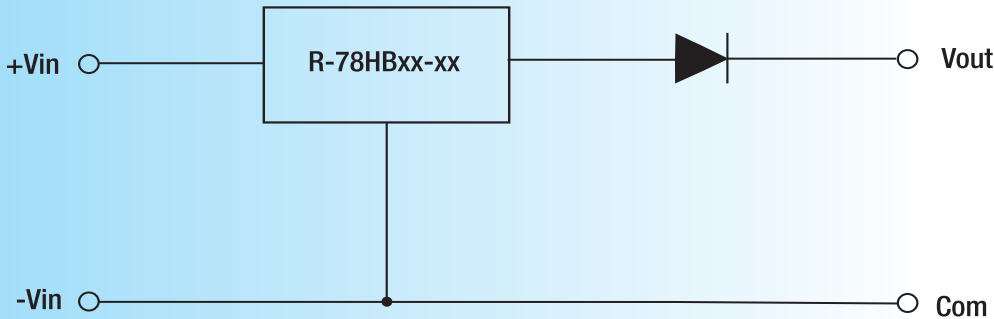

Add a blocking diode to Vout if current can flow backwards into the output, as this can damage the converter when it is powered down.

## Typical Application

### High Input Voltage Multiple Output Supply

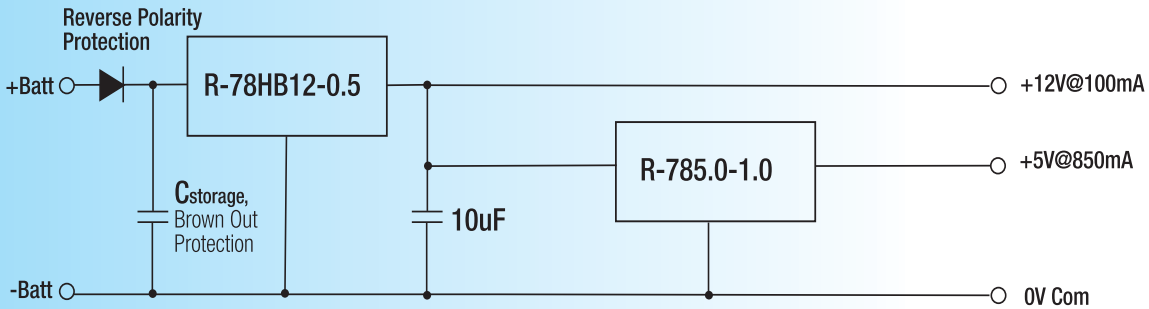

- Wide input range 18V to 72V - can be used with 24V, 48V or 60V batteries
- +12V output for interface and display electronics
- +5V high current output for digital electronics
- Further decoupling filtering may be necessary between the converters

## Package Style and Pinning (mm)

### SIP3 PIN Package

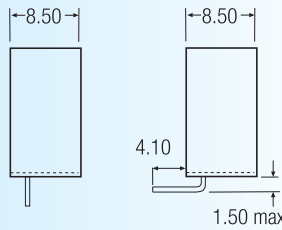
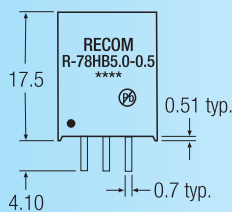

### L - Version

### Recommended Footprint Details

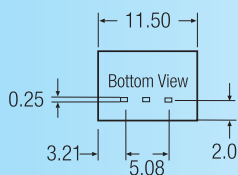
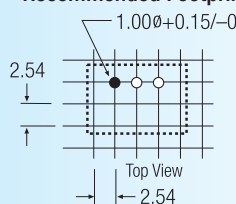

3rd angle projection

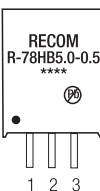

### Pin Connections

Pin #	Connection
1	+Vin
2	GND
3	+Vout

xx.x ±0.5mm  
xx.xx ±0.25mm